

Does the Magnesium(II) Ion Interact with the α -Phosphate of Adenosine Triphosphate? An Investigation by Oxygen-17 Nuclear Magnetic Resonance[†]

Shuyen L. Huang and Ming-Daw Tsai*

ABSTRACT: The binding of Mg^{2+} with adenine nucleotides is an important problem in enzyme-catalyzed phosphoryl transfer reactions. The previously used ^{31}P chemical shift method has been shown to be inadequate to define the chelation pattern of the Mg^{2+} complex with adenosine 5'-triphosphate (ATP) [Jaffe, E. K., & Cohn, M. (1978) *Biochemistry* 17, 652-657]. The center of controversy is whether the α -phosphate of ATP is involved in chelation. We have recently found that Mg^{2+} causes the ^{17}O NMR signal of $[\gamma\text{-}^{17}O_3]ATP$ to broaden [Tsai, M.-D., Huang, S. L., Kozlowski, J. F., & Chang, C. C. (1980) *Biochemistry* 19, 3531-3536]. The ^{17}O NMR method was then used to investigate the binding of Mg^{2+} with ATP and adenosine 5'-diphosphate (ADP). The results indicate that Mg^{2+} interacts with both the α - and β -phosphate of ADP, and all the α -, β -, and γ -phosphates of ATP. The extent of α

coordination in $MgATP$ may be smaller than the β and γ coordination. These results establish the "macroscopic" structure of $MgADP$ and $MgATP$ but have not determined the "microscopic" structures. The site specificity of the line-broadening effect in ^{17}O NMR was supported by the results from substitution-inert Co^{3+} complexes of ADP and ATP with known structures. The Co^{3+} coordination also causes a large upfield shift (180-200 ppm). Various experiments were performed to ensure that the nonspecific factors (factors unrelated to the quadrupolar effect of ^{17}O) do not dominate the results, although a small contribution from them cannot be ruled out. The experimental problems and the detailed mechanism of the line-broadening effect in ^{17}O NMR are discussed.

Most of the enzyme-catalyzed phosphoryl transfer reactions require some metal ion as a cofactor. The prerequisite of understanding what metal ions might be doing in catalysis is to know where they are located. Although some metals also interact with the base part of nucleotides (Cohn & Hughes, 1962; Lam et al., 1974), the binding with the phosphate portion is more important in phosphoryl transfer reactions. In the past two decades this problem has been extensively investigated by the ^{31}P relaxation method, which allows calculation of the distances between metal ions and phosphorus nuclei on the basis of the effect of paramagnetic metal ions on ^{31}P relaxation times (Mildvan & Cohn, 1970; Brown et al., 1973; Mildvan, 1977, 1979). Recently Cleland and co-workers have prepared various isomers of substitution-inert nucleotide complexes of Co^{3+} and Cr^{3+} and established their structures by X-ray, NMR, and CD¹ methods (Cleland & Mildvan, 1979; Cornelius et al., 1977; Merritt et al., 1978; Dunaway-Mariano & Cleland, 1980a). These complexes of known structure are then tested for their activity toward some specific enzymes to probe the chelation pattern of metal-nucleotide complexes in enzyme-catalyzed reactions (Dunaway-Mariano & Cleland, 1980b). Jaffe & Cohn (1979) have suggested that a metal-dependent stereospecificity reversal (e.g., for the diastereomers of $ATP\beta S$) is an indication for the involvement of that phosphoryl group in metal chelation during catalysis.

However, the most important and ubiquitous metal ion in enzyme-catalyzed phosphoryl transfer reactions is Mg^{2+} which is neither paramagnetic nor substitution inert. There is so far not a direct and unambiguous method to observe the binding of diamagnetic metal ions with nucleotides even in nonenzymatic systems. In this paper we propose a new approach by use of ^{17}O NMR to study such problems.

Although other methods such as IR (Brintzinger, 1963) have been employed, the most widely used method is ^{31}P NMR. On the basis of ^{31}P chemical shift changes, Cohn & Hughes (1962) first reported that $MgATP$ is a β, γ -bidentate (upon binding with Mg^{2+} at pH 8.0, the P_α signal shifts only 0.2 ppm downfield whereas the P_β signal shifts 2.2 ppm downfield and the P_γ signal shifts 0.5 ppm downfield; the coupling constants $J_{\alpha\beta}$ and $J_{\beta\gamma}$ both decrease from 20 to 15 Hz). However, on the basis of essentially the same ^{31}P NMR data, Kuntz & Swift (1973) have concluded that the $MgATP$ is an α, β, γ -tridentate whereas Tran-Dinh et al. (1975) have concluded that the $MgATP$ is a β -monodentate. Gupta & Mildvan (1977) have argued that since the chemical shift and coupling constant of the P_α signal of ATP behave quite similarly to those of the P_α signal of ADP, and since $MgADP$ is believed to be an α, β -bidentate, the Mg^{2+} should also interact with the α -phosphate of ATP. Recently Ramirez & Marecek (1980) suggest that $MgATP$ is a mixture of α, β -, β, γ -, and α, γ -bidentates, whereas Bishop et al. (1981) suggest that $MgATP$ is predominantly an α, β, γ -tridentate.

The criticism to the ^{31}P chemical shift method is best presented by Jaffe & Cohn (1978). They have pointed out

[†] From the Department of Chemistry, The Ohio State University, Columbus, Ohio 43210. Received May 7, 1981. This work was initiated at Purdue University, Lafayette, IN, and supported in part by National Institutes of Health Research Grant GM 26839 and National Science Foundation Research Grant PCM-8140443. The revised manuscript was completed at The Ohio State University. The NMR facilities used are supported by the following grants: NIH RR 01077 (at Purdue University), NSF CHE 79-16100 (at the University of Illinois), and NIH GM 27431 (at The Ohio State University). The results of this work have been presented in the Great Lakes Regional Meeting of the American Chemical Society, Dayton, OH, May 20-22, 1981.

¹ Abbreviations: O, oxygen-16; \emptyset , oxygen-17; P_i , inorganic orthophosphate; AMP, adenosine 5'-phosphate; ADP, adenosine 5'-diphosphate; ATP, adenosine 5'-triphosphate; AMPS, adenosine 5'-thio-phosphate; $ATP\beta S$, adenosine 5'-(2-thiotriphosphate); $ATP\gamma S$, adenosine 5'-(3-thiotriphosphate); PEP, phosphoenolpyruvate; EDTA, ethylenediaminetetraacetate; S/N, signal/noise ratio; DE, preacquisition delay; CD, circular dichroism.

that there is no compelling reason for expecting the magnitude of the chemical shift change to be related to the site of Mg^{2+} binding, since the magnitude of the chemical shift change has been shown to be unrelated to the site of binding of a proton (Myers, 1967; Tran-Dinh & Raoux, 1977).

In our recent paper (Tsai et al., 1980) which discusses the general applicability of the $^{31}P(^{17}O)$ NMR method, we have shown that Mg^{2+} causes the ^{17}O NMR signal of $[\gamma-^{17}O_3]ATP$ to broaden and decrease at a low magnetic field and suggested that the method could be very useful to resolve the $MgATP$ problem. In the present paper we report the details of the ^{17}O NMR method, the results on the study of Mg^{2+} binding with ^{17}O -labeled AMP, ADP, and ATP at different magnetic fields, and various control experiments including the use of substitution-inert Co^{3+} complexes.

Rationale

A nucleus with nuclear spin I greater than $1/2$ possesses an electric quadrupole moment eQ . The dominant relaxation mechanism for quadrupolar nuclei comes from interactions of eQ with an electric field gradient eq at the nucleus and the modulation of these interactions by rotational motion (James, 1975). In the extreme narrowing conditions, i.e., very fast molecular motions with respect to resonance frequency, which is the case for small molecules in solution, the contribution of nuclear quadrupole relaxation to the relaxation rate can be expressed as (Abragam, 1961)

$$\frac{1}{T_q} \approx \frac{1}{T_{1q}} \approx \frac{1}{T_{2q}} \approx \frac{3}{40} \left[\frac{2I+3}{I^2(2I-1)} \right] \left(1 + \frac{\eta^2}{3} \right) \left(\frac{e^2qQ}{\hbar} \right)^2 \tau_r \quad (1)$$

where e^2qQ/h is the quadrupole coupling constant, η is the asymmetry parameter, and τ_r is the rotational correlation time.

It is well established that the NMR signal of a quadrupolar ion broadens upon binding with macromolecules, presumably due to changes in both the electric field gradient eq (or the quadrupolar coupling constant e^2qQ/h) and the rotational correlation time τ_r (James, 1975; Wuthrich, 1976). Such a line-broadening effect has been widely used to study binding problems of quadrupolar ions (Villafranca & Raushel, 1980; Bryant, 1978). For example, it has been shown that the NMR signal of $^{25}Mg^{2+}$ broadens upon binding with ATP (Magnusson & Bothner-by, 1971; Bryant, 1972).

Our approach is to label the nucleotides with ^{17}O at various positions and observe the effect of binding with diamagnetic metal ions on the ^{17}O NMR signal.

Materials and Methods

Materials. The $H_2^{17}O$ (52.8% and 52.4%) was obtained from Monsanto. The puratronic grade (99.999% pure) $Mg(NO_3)_2$, $Ca(NO_3)_2$, $Zn(NO_3)_2$, $Cd(NO_3)_2$, and $MnCl_2$ were purchased from Ventron Co. Carbamate kinase (*Streptococcus faecalis*; 700–1000 units/mg) was purchased from Sigma. Myokinase (rabbit muscle, 360 units/mg) and pyruvate kinase (rabbit muscle, 200 units/mg) were obtained from Boehringer. Other enzymes were obtained as previously described (Tsai et al., 1980; Tsai, 1980). Other biochemicals were obtained from Sigma or Boehringer. DEAE-Sephadex A-25 was purchased from Pharmacia. Other chemicals used were of reagent grade or highest purity available commercially.

Preparation of ^{17}O -Labeled Nucleotides. $[\gamma-^{17}O_3]ATP$ (III) (40 atom % ^{17}O) was prepared as previously described (Tsai et al., 1980). $[\alpha-^{17}O_2]AMPS$ (X) (49 atom % ^{17}O) was

Scheme I

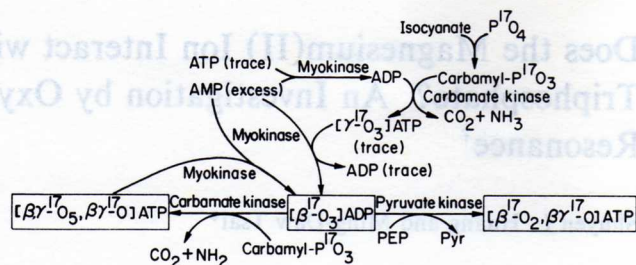

Scheme II

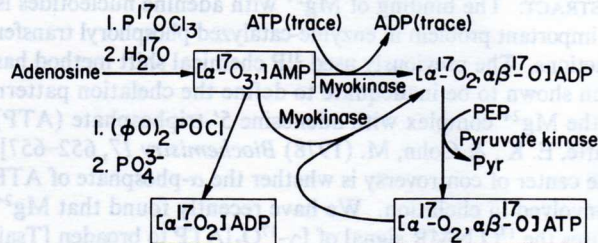

prepared as previously described for the synthesis of $[\alpha-^{18}O_2]AMPS$ (Tsai, 1980). $[\gamma-^{17}O_2]ATP\gamma S$ (IX) (35 atom % ^{17}O) was prepared from $PS^{17}O_3^{3-}$ according to the procedure previously used for the preparation of $[\gamma-^{18}O_2]ATP\gamma S$ (Tsai, 1980).

Scheme I summarizes the synthetic procedure of $[\beta-^{17}O_2, \beta\gamma-^{17}O]ATP$ (II) and $[\beta-^{17}O_3]ADP$ (V). $[\beta-^{17}O_3]ADP$ (V) (40 atom % ^{17}O) was prepared according to the procedure of Cohn & Hu (1980) for the preparation of $[\beta-^{18}O_3]ADP$, except that the isolated byproduct $[\beta-^{17}O_2, \beta\gamma-^{17}O, \gamma-^{17}O_3]ATP$ was converted back to two molecules of $[\beta-^{17}O_3]ADP$ by transferring the $\gamma-P^{17}O_3$ group to AMP catalyzed by adenylate kinase. Product V from all fractions was combined together. $[\beta-^{17}O_2, \beta\gamma-^{17}O]ATP$ (II) was obtained from V by reacting with phosphoenolpyruvate (PEP) catalyzed by pyruvate kinase.

$[\alpha-^{17}O_3]AMP$ (VI) (38 atom % ^{17}O), $[\alpha-^{17}O_2]ADP$ (IV) (40 atom % ^{17}O), and $[\alpha-^{17}O_2, \alpha\beta-^{17}O]ATP$ (I) (38 atom % ^{17}O) were prepared according to the procedures summarized in Scheme II. $P^{17}OCl_3$ was prepared from PCl_5 and $H_2^{17}O$ by the procedure of Abbott et al. (1979). Reaction of $P^{17}OCl_3$ with adenosine (free acid, suspended in anhydrous triethyl phosphate) in a 1:1 ratio followed by hydrolysis with $H_2^{17}O$ (2 times excess in equivalent amounts) at room temperature gave $[\alpha-^{17}O_3]AMP$. The reaction mixture was evaporated under vacuum to remove HCl, then neutralized with NaOH, and separated by the DEAE column (ammonium bicarbonate). The purified $[\alpha-^{17}O_3]AMP$ was converted to $[\alpha-^{17}O_2, \alpha\beta-^{17}O]ATP$ by incubation with trace ATP, excess PEP, and myokinase and pyruvate kinase, followed by chromatograph in a DEAE column (triethylammonium bicarbonate). $[\alpha-^{17}O_2, \alpha\beta-^{17}O]ADP$ has also been isolated as a byproduct which has been used in some preliminary study.

The $[\alpha-^{17}O_2]ADP$ (IV) was prepared from $[\alpha-^{17}O_3]AMP$ according to the procedure used for the synthesis of ADP αS from AMPS (Eckstein & Goody, 1976). The pyridinium salt of AMP was first reacted with diphenyl phosphorochloridate, followed by treating with nonlabeled PO_4^{3-} .

The $[\beta-^{17}O_2, \alpha\beta, \beta\gamma-^{17}O_2]ATP$ (VII) and $[\beta-^{17}O_3, \alpha\beta-^{17}O]ADP$ (VIII) are available from previous work (Tsai, 1979).

The atom % ^{17}O enrichment for the above-labeled nucleotides was determined either by the integration method of Tsai (1979) (assuming each labeled position is equally enriched) or by determining the ^{18}O enrichment in the residual signal of non- ^{17}O species. The ^{17}O enrichment can then be calculated

on the basis of the known $^{17}O/^{18}O$ ratio in the $[^{17}O]$ water used.

The procedures of Cornelius et al. (1977) were used to prepare the following substitution-inert Co^{3+} complexes of ^{17}O -labeled nucleotides: $Co(NH_3)_4[\alpha-^{17}O_2]ADP$ (α,β -bidentate) (XIV); $Co(NH_3)_4[\beta-^{17}O_3]ADP$ (α,β -bidentate) (XV); $Co(NH_3)_4[\alpha-^{17}O_2,\alpha\beta-^{17}O]ATP$ (β,γ -bidentate) (XI); $Co(NH_3)_4[\beta-^{17}O_2,\beta\gamma-^{17}O]ATP$ (β,γ -bidentate) (XII); $Co(NH_3)_4[\gamma-^{17}O_3]ATP$ (β,γ -bidentate) (XIII). The product was identified by ^{31}P NMR. The complex always slowly decomposes. The purity was determined to be 85–90% by ^{31}P NMR after ^{17}O experiments.

Preparation of NMR Samples. The concentration of NMR samples varies from 25 to 100 mM, which is specified in tables and figures. D_2O was used as the solvent in all cases. Unless specified, all samples were prepared at pD 7.6. The pD values represent the direct reading on the pH meter without correcting for the deuterium isotope effect. All glasswares were soaked with an EDTA solution before use. Samples were treated with Chelex-100 for 20 min, except that the Co^{3+} complexes were treated for only 2 min to avoid decomposition. All samples, unless otherwise specified, contained 2% EDTA (relative to the nucleotide concentration). The metal ion solution was prepared by dissolving the puratronic grade metal nitrate (with one exception, manganese chloride) in D_2O (2.04 M) and adjusted to pD 7.6 with NaOD. The solution of metal-nucleotide complexes was prepared by adding the calculated volume of the metal ion solution into the nucleotide solution. NaOD and DCl were used to adjust pD in pD-dependent studies. In most cases a ^{31}P NMR spectrum was taken after ^{17}O experiments to ensure the sample purity. In addition, we found that Mn^{2+} broadened both the nucleotide signal and the solvent signal appreciably, whereas diamagnetic metal ions had a much smaller effect on the solvent signal. The above controls ensured that the reported results were not dominated by paramagnetic impurities.

NMR Parameters. The following instruments have been used for ^{17}O NMR: Varian FT-80 (1.88 T, 10.85 MHz) (deuterium lock, spinning, 1-mL sample); JEOL FX-90Q (2.11 T, 12.2 MHz) (deuterium lock, spinning, 1-mL sample); Bruker CXP-180 in Dr. Fiat's laboratory (4.22 T, 24.4 MHz) (nonspinning, 1-mL sample); Bruker WP-200 (4.67 T, 27.11 MHz) (spinning, 1.5-mL sample, deuterium lock); NSF-250 of the NSF Regional Facility at the University of Illinois (5.87 T, 33.9 MHz) (sideway spinning, 1-mL sample in a microcell made of Teflon); Bruker CXP-300 (7.05 T, 40.67 MHz) (nonspinning, 1.5-mL sample) at Procter and Gamble; EO-360 in Dr. Oldfield's laboratory (8.46 T, 48.8 MHz) (nonspinning, 0.5-mL sample). All experiments were done at ambient temperature unless specified. The chemical shifts reported are relative to external $H_2^{17}O$, with the positive sign representing a downfield shift.

The following instruments have been used for ^{31}P NMR: Varian FT-80 (1.88 T, 32.4 MHz); Bruker WP-200 and Nicolet NTC-200 (4.70 T, 80.98 MHz); Nicolet NTC-360 (8.46 T, 145.76 MHz); Nicolet NTC-470 (11.04 T, 190.26 MHz). Deuterium lock was used in all cases. The purpose of ^{31}P NMR experiments in this work can be divided into three categories: (a) routine analysis for sample purity, (b) analysis of ^{17}O enrichment based on integration (Tsai et al., 1980), and (c) analysis of ^{17}O enrichment based on the ^{18}O isotope shift (Cohn & Hu, 1978) and the known ratio of $^{17}O/^{18}O$.

Data Analysis of ^{17}O NMR. Several important points should be encountered in the interpretation of ^{17}O NMR results. (1) Not every ^{17}O nucleus will give an observable signal. A signal may be too broad to be detected, depending on the

power of the instrument, the DE value used, and the sample concentration. A very short DE (0–50 μs) should be used for a very broad signal (>1000 Hz). However, use of a short DE inevitably will result in a rolling base line (Canet et al., 1976). The high-power probe of the Bruker CXP-300 spectrometer was found most suitable for the present work. (2) The relative peak intensity may not represent the relative concentration of different species unless they happen to have the same line width. (3) Binding of diamagnetic metal ions causes the ^{17}O NMR signal of nucleotide to "broaden" and "decrease". Only the broadening can provide a quantitative measure of the binding effect. The signal "decrease" is dependent on instrumental conditions.

Results and Discussion

Binding of Mg^{2+} with Adenine Nucleotides. The major advantages of the ^{17}O NMR method over the previously used ^{31}P chemical shift method are that ^{17}O NMR directly observes the ^{17}O nucleus which is directly involved in binding and that the quadrupolar effect is mainly intramolecular and is sensitive to the close environment of the ^{17}O nucleus. We have therefore prepared the following ^{17}O -labeled adenine nucleotides for ^{17}O NMR study:

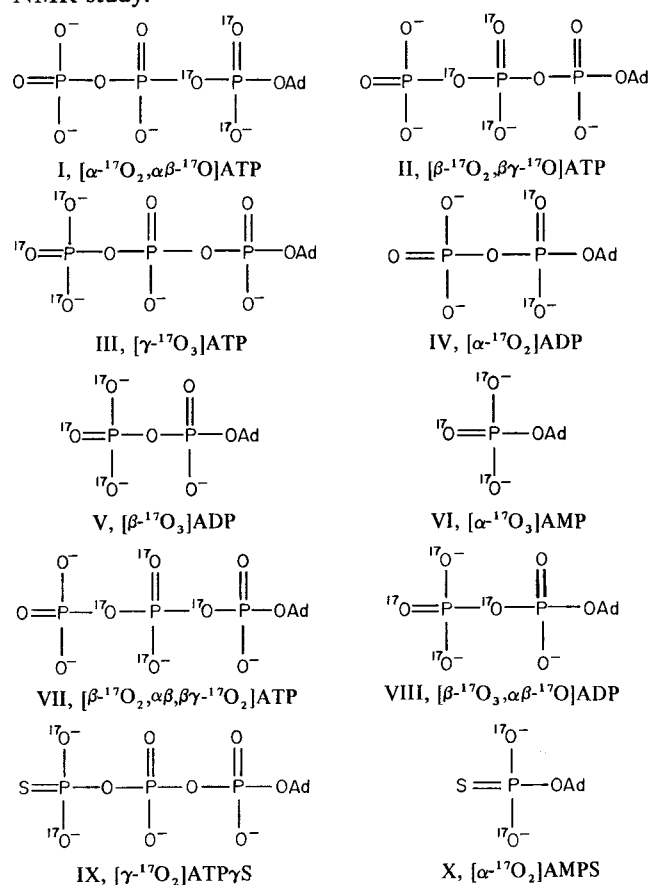

Figure 1 shows the titration curve of the ΔO of $[\gamma-^{17}O_3]ATP$ (III) vs. the ratio $[Mg^{2+}]/[ATP]$ in a low magnetic field (1.88T, 10.85 MHz). The ΔO of III increases approximately linearly up to $[Mg^{2+}]/[ATP] = 1.0$. The reason for the small increase in ΔO after $[Mg^{2+}]/[ATP] > 1.0$ is not clear. In the following discussion the "complex" refers to a 1:1 ratio of $[metal]/[nucleotide]$, unless otherwise specified.

Figure 2 shows the high-field (40.67 MHz) ^{17}O NMR spectra of nucleotides I–V and their Mg^{2+} complexes obtained in the high-power probe of the CXP-300. In all cases the sharper signal is due to the solvent (D_2O) and the broader signal due to nonbridge ^{17}O of nucleotides. The signal of

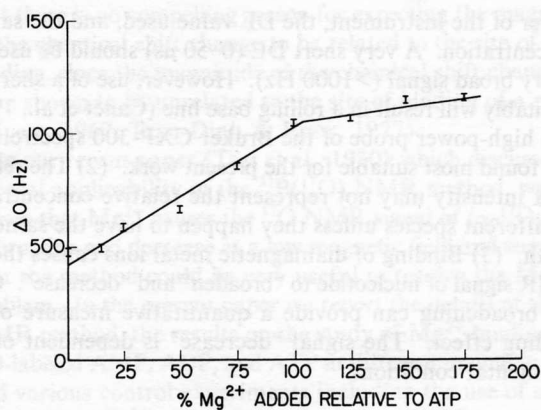

FIGURE 1: ^{17}O line widths of $[\gamma\text{-}^{17}\text{O}_3]\text{ATP}$ (III) as a function of $\text{Mg}(\text{NO}_3)_2$ concentration at low field (1.88 T, 10.85 MHz). Sample condition: 25 mM in D_2O , pD 7.6. Spectrometer (Varian FT-80) condition: 1K data points, sweep width 8 KHz, DE = 200 μs , deuterium lock, recycle time 120 ms, line broadening 10 Hz. The spectra of this experiment are shown in Figure 5B. The ΔO in the plot has not been corrected for exponential multiplication and $J_{\text{P-O}}$.

Table I: Summary of ^{17}O NMR Results in Mg^{2+} -Nucleotide Interactions

nucleotide	position		concn (mM)	spectrometer parameters		R values
	obsd	compd		freq (MHz)	DE (μs)	
ATP	α	I	25	40.67	10	1.1
ATP	α	I	45	33.9	400	0.9
ATP	α	I	25	27.11	1	0.7
ATP	α	I	100	24.4		0.9
ATP	α	I	100	12.2	50	0.8
ATP	β	II	25	40.67	10	1.4
ATP	β	II	45	33.9	400	1.7
ATP	β	II	45	33.9	100	2.0
ATP	β	II	25	27.11	1	1.7
ATP	β	VII	25	48.8		1.4
ATP	β	VII	25	10.85	200	1.4
ATP	γ	III	25	40.67	10	2.5
ATP	γ	III	45	33.9	400	1.8
ATP	γ	III	25	27.11	1	2.1
ATP	γ	III	25	10.85	200	1.8
ADP	α	IV	25	40.67	10	1.2
ADP	α	IV	45	33.9	400	1.7
ADP	α	IV	45	33.9	100	1.8
ADP	α	IV	25	27.11	1	1.3
ADP	β	V	25	40.67	10	2.2
ADP	β	V	45	33.9	400	2.0
ADP	β	V	45	33.9	100	2.0
ADP	β	V	25	27.11	1	1.4
ADP	β	VIII	25	48.8		1.6
ADP	β	VIII	25	10.85	200	1.7
AMP	α	VI	25	10.85	200	0.4

P-O-P bridge ^{17}O is not readily detectable² (Tsai et al., 1980). Table I summarizes the results from Figure 2 and the experiments with nucleotides I-VIII on other spectrometers under various conditions.

In Table I, the "line-broadening effect" in ^{17}O NMR is measured by the defined "R" value:

$$R = \frac{\Delta\text{O}_b - \Delta\text{O}_f}{\Delta\text{O}_f} \quad (2)$$

² There is a piece of evidence for the bridge ^{17}O signal at 120-125 ppm, with $\Delta\text{O} \approx 1600$ Hz. The signal becomes obvious at elevated temperatures. However, since it is partially overlapped with the non-bridge ^{17}O signal, it is to be further confirmed by singly labeled nucleotides.

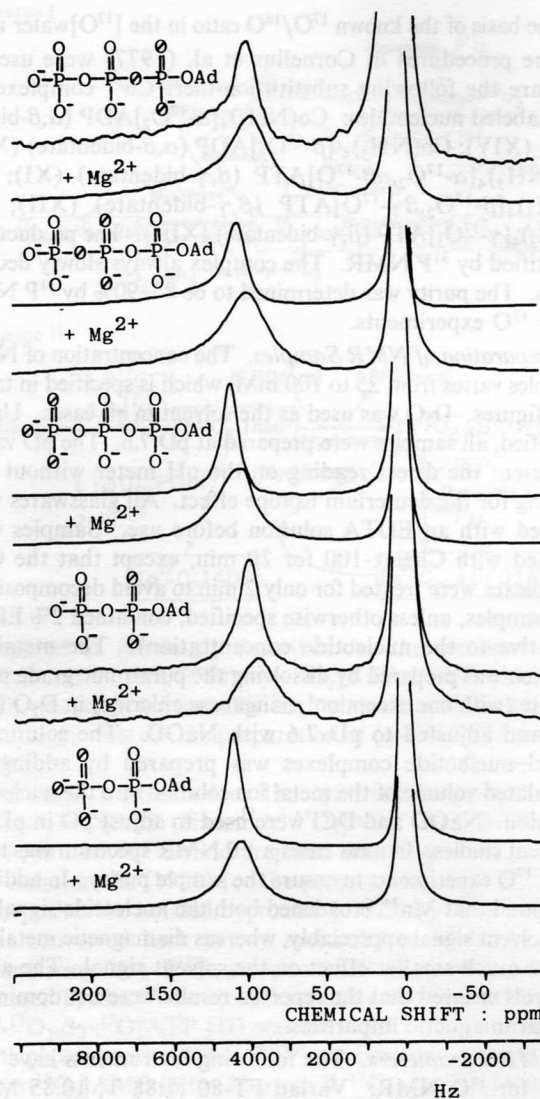

FIGURE 2: ^{17}O NMR spectra at 40.67 MHz showing the "line-broadening effect" of Mg^{2+} coordination for the ^{17}O -labeled nucleotides I-V. Sample condition: 25 mM in D_2O , pD 7.8. Spectrometer parameters (CXP-300): 4K data points, sweep width 50 kHz, DE = 10 μs , recycle time 110 ms, line broadening 120 Hz, unlocked, nonspinning, 2000-5000 transients. The sharper peak at -3 ppm is due to solvent.

where ΔO_f and ΔO_b represent the "corrected" ^{17}O line widths for the free and bound nucleotides, respectively. The "corrected" line widths ΔO_b and ΔO_f are obtained by subtracting from the measured line widths at half-height the line-broadening factors unrelated to the quadrupolar effect: the artificially applied exponential multiplication, the field inhomogeneity due to the nonspinning mode used in some experiments, and the broadening due to ^{31}P - ^{17}O spin-spin coupling which is approximated as 110 Hz on the basis of the data obtained for a number of adenine nucleotides.³ Possible changes in $J_{\text{P-O}}$ upon coordination have not been considered. The experiments at 24.4, 40.7, and 48.8 MHz were done in a nonspinning mode; therefore the observed line widths are further corrected for additional 50 Hz due to field inhomogeneity.

The results in the last column of Table I show that Mg^{2+} interacts approximately equally with the α -phosphate ($R \approx 1.2$ -1.8) and β -phosphate ($R \approx 1.4$ -2.2) of ADP and the β -phosphate ($R \approx 1.4$ -2.0) and γ -phosphate ($R \approx 1.8$ -2.5)

³ J. A. Gerlt, P. C. Demou, and S. Mehdi, private communication.

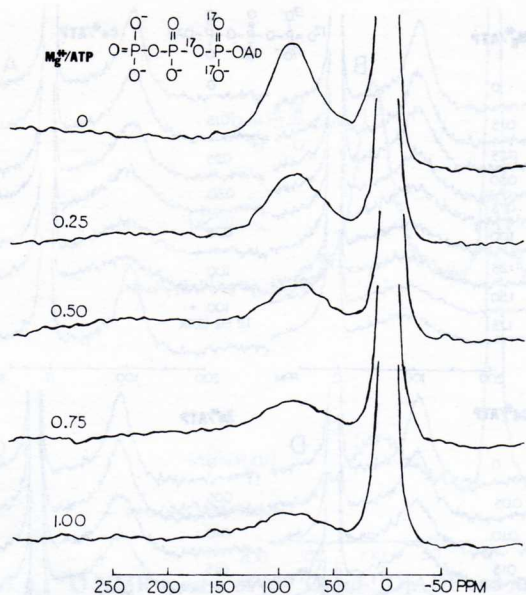

FIGURE 3: Effect of Mg^{2+} on the ^{17}O NMR spectra of $[\alpha\text{-}^{17}O_2, \alpha\beta\text{-}^{17}O]ATP$ (I) in a low magnetic field (2.11 T, 12.2 MHz). Sample condition: 100 mM in D_2O , pD 7.6. Spectrometer (JEOL FX-90Q) condition: Sweep width 10 kHz, 1 K data points, DE = 50.5 μs , deuterium lock, line broadening 10 Hz, recycle time 160 ms, 10000 transients. The sharper peak at -3 ppm is due to solvent.

of ATP. The Mg^{2+} ion also interacts with the α -phosphate of ATP but to a somewhat smaller extent ($R \approx 0.7\text{--}1.1$) than its interaction with β - and γ -phosphates. The results of Mg^{2+} coordination with the α -phosphate have been reproduced in five different instruments. Figure 3 shows the low-field ^{17}O NMR spectra for the titration of $[\alpha\text{-}^{17}O_2, \alpha\beta\text{-}^{17}O]ATP$ with Mg^{2+} . These results indicate that the α -phosphate of ATP is involved in the interaction with Mg^{2+} .

Quantitation and Uncertainty of the Results. The results in Table I should not be overinterpreted. MgATP can have seven different structural isomers (α -, β -, and γ -monodentate, α, β -, β, γ -, and α, γ -bidentate, and α, β, γ -tridentate). Since the α phosphorus and β phosphorus are prochiral centers, it is possible to have two stereoisomers for the α -monodentate, the β -monodentate, the β, γ -bidentate, and the α, γ -bidentate and four stereoisomers for the α, β -bidentate and the α, β, γ -tridentate. Therefore the MgATP can be a mixture of 17 different stereoisomers. The results in Table I give only the macroscopic view of the MgATP structure. It is not possible at this stage to determine whether MgATP is a mixture of β, γ -bidentate and α, β, γ -tridentate, or others.

In addition to this complexity, there is also some limitation in the methodology. First, the accuracy in the ΔO depends on the S/N ratio and on the spectrometer used. It can be accurate within $\pm 5\%$ for sharper signals, but the error can be as large as $\pm 10\text{--}20\%$ for very broad and distorted signals. Therefore the R values in Table I should be considered to be accurate only within $\pm 20\%$.

Second, could the observed "line-broadening effect" be due to some nonspecific factors such as "pH", "exchange processes", "viscosity", or even an "increase in J_{P-O} " upon chelation?

Third, the mechanism of the line-broadening effect is far from clear. Some obvious questions are the following: (1) Is the effect specific to the site of binding at different phosphate groups? Within the same phosphate group, how do the two (or three at the terminal phosphate) prochiral oxygens behave differently upon chelation? (2) Is the magnitude of R values related to the extent of binding? To the formation constant of the complex? To the distance between the metal

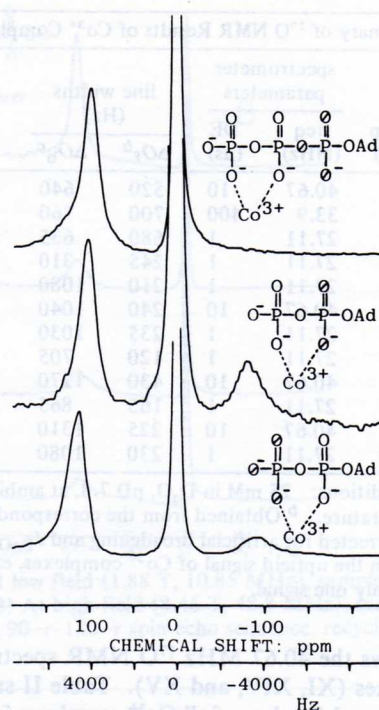

FIGURE 4: ^{17}O NMR spectra of the Co^{3+} complexes XI, XIV, and XV at 40.67 MHz. Sample conditions and spectrometer conditions are same as those of Figure 2.

ion and the oxygen? (3) Is τ_r , or e^2qQ/h the major factor which changes upon coordination?

In the following sections we present results which shed light on some of the above questions and show that nonspecific factors should not dominate the results in Table I, although they may have affected the R values to a small extent.

Use of Substitution-Inert Co^{3+} Complexes to Establish Site Specificity. To unequivocally establish the site specificity of the line-broadening effect in ^{17}O NMR, we prepared the following diamagnetic substitution-inert Co^{3+} complexes of ATP (β, γ -bidentate) and ADP (α, β -bidentate) (Cornelius et al., 1977; Cleland, 1982):

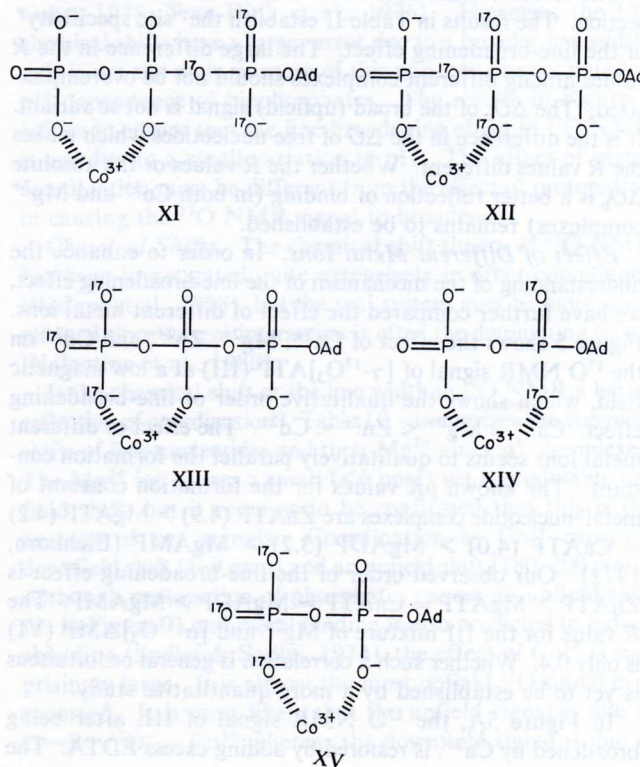

Table II: Summary of ^{17}O NMR Results of Co^{3+} Complexes^a

labeled complex	temp (°C)	spectrometer parameters		line widths (Hz)		R
		freq (MHz)	DE (μs)	ΔO_f^b	ΔO_b^c	
XI		40.67	10	520	640	0.23
		33.9	400	700	760	0.08
	30	27.11	1	680	635	-0.07
	65	27.11	1	245	310	0.26
XII	65	27.11	1	210	1080	4.1
XIII		40.67	10	240	1040	3.3
	30	27.11	1	235	1030	3.4
	65	27.11	1	120	705	4.8
XIV		40.67	10	430	1270	2.0
	65	27.11	1	165	865	4.2
XV		40.67	10	225	1310	4.8
	30	27.11	1	230	1080	3.7

^a Sample conditions: 25 mM in D_2O , pD 7.8, at ambient or specified temperature. ^b Obtained from the corresponding free nucleotides, corrected for artificial broadening and $J_{\text{P-O}}$. ^c Obtained from the upfield signal of Co^{3+} complexes, except for XI which has only one signal.

Figure 4 shows the 40.67 MHz ^{17}O NMR spectra of some Co^{3+} complexes (XI, XIV, and XV). Table II summarizes the line widths and R values of all Co^{3+} complexes from Figure 4 and other experiments.

In XI, the $\alpha\text{-}^{17}\text{O}$ is not directly coordinated, and the ^{17}O NMR of XI shows little variation in both ΔO and chemical shift from that of the corresponding free nucleotide I. For all other complexes, in which there is a direct coordination, a downfield and an upfield peaks are observed, presumably due to $^{17}\text{O}=\text{P}-\text{O}^- \dots \text{Co}^{3+}$ and $\text{O}=\text{P}-^{17}\text{O}^- \dots \text{Co}^{3+}$. The downfield peak is slightly shifted (1–9 ppm) from the free nucleotide signal and slightly broadened. The upfield signal is greatly shifted (180–200 ppm) from the free nucleotide signal and extensively broadened. Since the upfield signal is very broad (>1000 Hz), it was readily observed only with the CXP-300 spectrometer and with the WP-200 when a short DE (1 μs) or a high temperature (60 °C) was used.

The effect of chemical shifts will be discussed in a later section. The results in Table II establish the "site specificity" of the line-broadening effect. The large difference in the R values among different complexes should not be overemphasized. The ΔO_b of the broad (upfield) signal is not so variant. It is the difference in the ΔO of free nucleotides which makes the R values different. Whether the R values or the absolute ΔO_b is a better reflection of binding (in both Co^{3+} and Mg^{2+} complexes) remains to be established.

Effect of Different Metal Ions. In order to enhance the understanding of the mechanism of the line-broadening effect, we have further compared the effect of different metal ions. Figure 5 shows the effect of Ca^{2+} , Mg^{2+} , Zn^{2+} , and Cd^{2+} on the ^{17}O NMR signal of $[\gamma\text{-}^{17}\text{O}_3]\text{ATP}$ (III) at a low magnetic field, which shows the qualitative order of line-broadening effect: $\text{Ca}^{2+} \approx \text{Mg}^{2+} < \text{Zn}^{2+} < \text{Cd}^{2+}$. The effect of different metal ions seems to qualitatively parallel the formation constant. The known pK values for the formation constant of metal-nucleotide complexes are ZnATP (4.9) > MgATP (4.2) \approx CaATP (4.0) > MgADP (3.2) > MgAMP (Eichhorn, 1972). Our observed order of the line-broadening effect is $\text{ZnATP} > \text{MgATP} \approx \text{CaATP} \approx \text{MgADP} > \text{MgAMP}$. The R value for the 1:1 mixture of Mg^{2+} and $[\alpha\text{-}^{17}\text{O}_3]\text{AMP}$ (VI) is only 0.4. Whether such a correlation is general or fortuitous is yet to be established by a more quantitative study.

In Figure 5A, the ^{17}O NMR signal of III, after being broadened by Ca^{2+} , is restored by adding excess EDTA. The

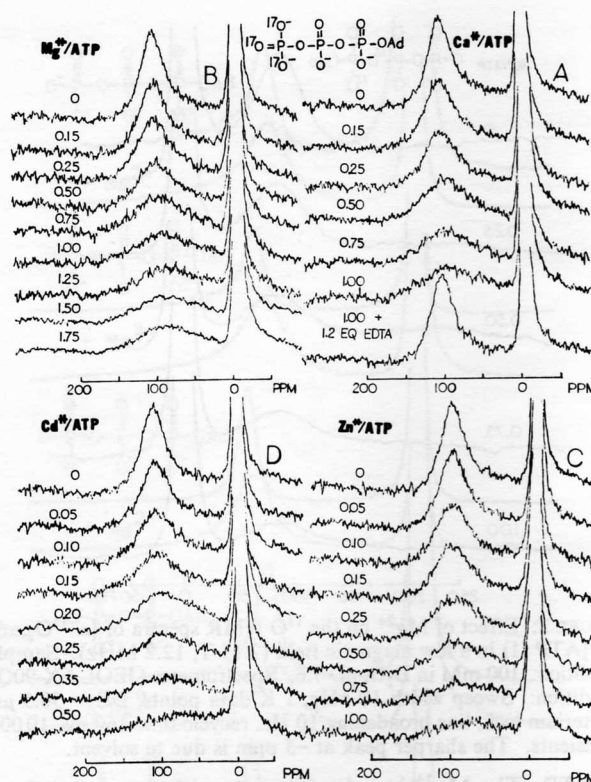

FIGURE 5: Low-field ^{17}O NMR spectra of $[\gamma\text{-}^{17}\text{O}_3]\text{ATP}$ (III) showing the effect of $\text{Ca}(\text{NO}_3)_2$ (A), $\text{Mg}(\text{NO}_3)_2$ (B), $\text{Zn}(\text{NO}_3)_2$ (C), and $\text{Cd}(\text{NO}_3)_2$ (D). Sample condition: 25 mM in D_2O , pD 7.6. Spectrometer (Varian FT-80) condition: same as that of Figure 1, 40000 transients for all spectra except the last two spectra in (B) which have 200 000 transients.

same effect has been found in many other cases. Thus, the possible viscosity change upon addition of metal salts can contribute little, if any, to the observed line broadening.

The same qualitative order ($\text{Ca}^{2+} \sim \text{Mg}^{2+} < \text{Zn}^{2+} < \text{Cd}^{2+}$) has also been observed in binding with $[\alpha\text{-}^{17}\text{O}_2]\text{AMPS}$ (X), where the enhanced effect of Zn^{2+} and Cd^{2+} could be due to their affinity to sulfur (Jaffe & Cohn, 1979). It implies that a "direct coordination" may not be required for line broadening within the same phosphoryl group, as also suggested by the small broadening in the $^{17}\text{O}=\text{P}-\text{O}^- \dots \text{Co}^{3+}$. The nature of such a broadening remains to be further investigated.

Effect of Exchange Processes. In all Mg^{2+} complexes only one signal has been observed. It remains to be established whether this signal is an average of $^{17}\text{O}=\text{P}-\text{O}^- \dots \text{Mg}^{2+}$ and $\text{O}=\text{P}-^{17}\text{O}^- \dots \text{Mg}^{2+}$ or represents only one of them (the other signal might be too broad to be detected). The exchange rate of MgATP has been found to be 2×10^4 (Bryant, 1972) or $1.2 \times 10^3 \text{ s}^{-1}$ (Diebler et al., 1960), which could be on the intermediate or slow exchange side on the basis of the separation between the two signals in Co^{3+} complexes. However, it is possible that Mg^{2+} may exchange rapidly between the two (or three) prochiral oxygens without being dissociated from the nucleotide. In addition, there are 17 possible isomers, and the theory of the NMR relaxation times in the presence of chemical exchange is quite complicated for quadrupolar nuclei (Swift & Connick, 1962; Marshall, 1970; Collins et al., 1973).

It is therefore not possible for us to quantitatively define the effect of exchange processes on the results in Table I. However, we present evidence which suggests that our results should not be dominated by such processes. (1) The exchange rate of CaATP is known to be $> 10^5 \text{ s}^{-1}$ (Diebler et al., 1960). On the other hand, the Co^{3+} complexes are substitution inert.

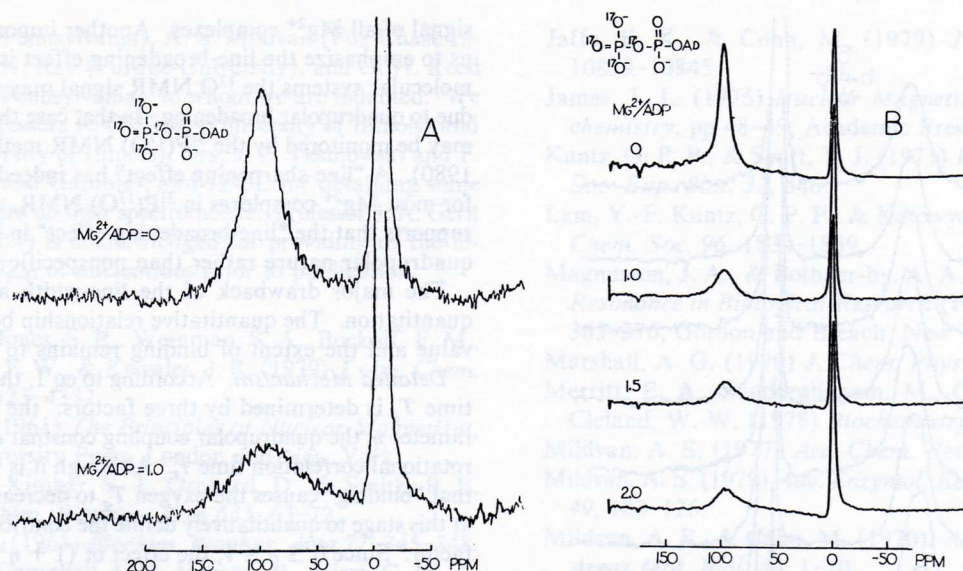

FIGURE 6: ^{17}O NMR spectra of $[\beta\text{-}^{17}O_3, \alpha\beta\text{-}^{17}O]$ ADP and its Mg^{2+} complex. (A) At low field (1.88 T, 10.85 MHz), sample condition: 25 mM in D_2O , pD 7.6. Spectrometer (FT-80) condition: same as that of Figure 1. (B) At high field (8.46 T, 48.8 MHz), sample condition: 25 mM in D_2O , pD 7.6. Spectrometer (EO-360) condition: unlocked, nonspinning, $90-\tau-180-\tau$ spin-echo sequence, recycle time 120 ms, line broadening 50 Hz, sweep width 20 kHz, 4K data points, 16 000 transients.

Table III: ^{17}O Chemical Shifts of Adenine Nucleotides at pD 7.8

compd	nucleotide	position	δ (free nucleotide)	δ (Co^{3+} complex) ^d		δ (Mg^{2+} complex) ^d
				downfield signal	upfield signal	
I	ATP	α	96 ^a	95 (-1)	-81 (-183)	94 (-2)
II	ATP	β	102 ^a	105 (+3)	-81 (-183)	97 (-5)
III	ATP	γ	106 ^a	115 (+9)	-89 (-195)	102 (-6)
IV	ADP	α	97 ^a	98 (+1)	-82 (-179)	91 (-6)
V	ADP	β	107 ^a	113 (+6)	-89 (-196)	104 (-3)
VI	AMP	α	103 ^b			
X	AMPS	α	146 ^{b,c}			
IX	ATP γ S	γ	156 ^b			

^a Obtained from the WP-200 spectrometer at 30 °C. The estimated error is ± 1 ppm for sharper signals and ± 2 ppm for broader signals.

^b Obtained from the Varian FT-80 spectrometer. Estimated error: ± 2 ppm. ^c A pH profile has been obtained, which shows a shift from 120 to 146 ppm upon deprotonation of the monoanion to the dianion, with an inflection point at pD 5.3. ^d Numbers in parentheses are shifts relative to free nucleotides.

Thus, the line-broadening effect is present in complexes in the slow-exchange limit ($CoATP$), in the intermediate range ($MgATP$), and in the rapid-exchange limit ($CaATP$). (2) For Mg^{2+} complexes which may possibly be in the intermediate range, the results in Table I do not show an appreciable dependence of R values (within the $\pm 20\%$ experimental error) on the magnetic field strength from 1.88 to 8.45 T. Figure 6 shows the ^{17}O NMR spectra of $[\beta\text{-}^{17}O_3, \alpha\beta\text{-}^{17}O]$ ADP and its Mg^{2+} complexes at low field (10.85 MHz, 1.88 T) (Figure 6A) and at high field (48.8 MHz, 8.45 T) (Figure 6B). These results suggest that the observed line-broadening effect is not dominated by chemical exchange processes, regardless of whether there is another broader undetected signal in Mg^{2+} complexes.

Effect of pH. Figure 7A shows the low-field (10.85 MHz) ^{17}O NMR spectra of $[^{17}O_4]P_i$ as a function of pH, which indicate that the ΔO (uncorrected for J_{P-O} , which may be pH dependent) is constant within 240 Hz ($\pm 8\%$). The ΔO of $[\gamma\text{-}^{17}O_3]ATP$ (III) is also constant within 390 Hz ($\pm 8\%$) at 27.11 MHz from pD 1.5 to 10.2 at 30 °C, whereas the ΔO of the Mg^{2+} complex of III seems to show a larger variation with pH, which is to be further investigated. Figure 7B shows the plot of ^{17}O chemical shifts (δO) vs. pH from the above titration experiments. In all cases protonation causes a 13–14 ppm decrease in δO . The inflection points correspond well to those of the titration curves of ^{31}P chemical shifts (Jaffe &

Cohn, 1978; Tran-Dinh et al., 1975). However, the ^{17}O chemical shifts have a larger error due to a broader line width.

It is not the main purpose of this paper to discuss detailed pH dependence of biophosphates. The results in Figure 7 suffice to ensure that the line-broadening effect in ^{17}O NMR is not due to a small variation in pH. The effect of metal coordination must be different from the effect of protonation in causing the ^{17}O NMR signal to broaden.

Chemical Shifts. The chemical shift theory of ^{17}O NMR has been investigated quite extensively in other compounds (Rodger et al., 1978), but the real system may be more complicated since solvent interaction is often the dominating factor (Valentine et al., 1980).

Is the chemical shift or the line width in ^{17}O NMR a better reflection of coordination? Table III summarizes the chemical shifts of free nucleotides and their Mg^{2+} and Co^{3+} complexes. The Mg^{2+} ion causes a small (< 6 ppm) yet reproducible upfield shift, but it remains to be confirmed that this is the average of two signals. Coordination by Co^{3+} causes a downfield shift (1–9 ppm) and an upfield shift (180–200 ppm). Although protonation of phosphates causes an upfield shift (as in Figure 7) and metal binding is also predicted to induce shielding (Sadlej & Sadlej, 1974), the effect of Co^{3+} is surprisingly large. It is almost the most upfield ^{17}O signal ever reported. It is most likely that the upfield signal is due to $O=P-^{17}O \dots Co^{3+}$ whereas the downfield signal is due to

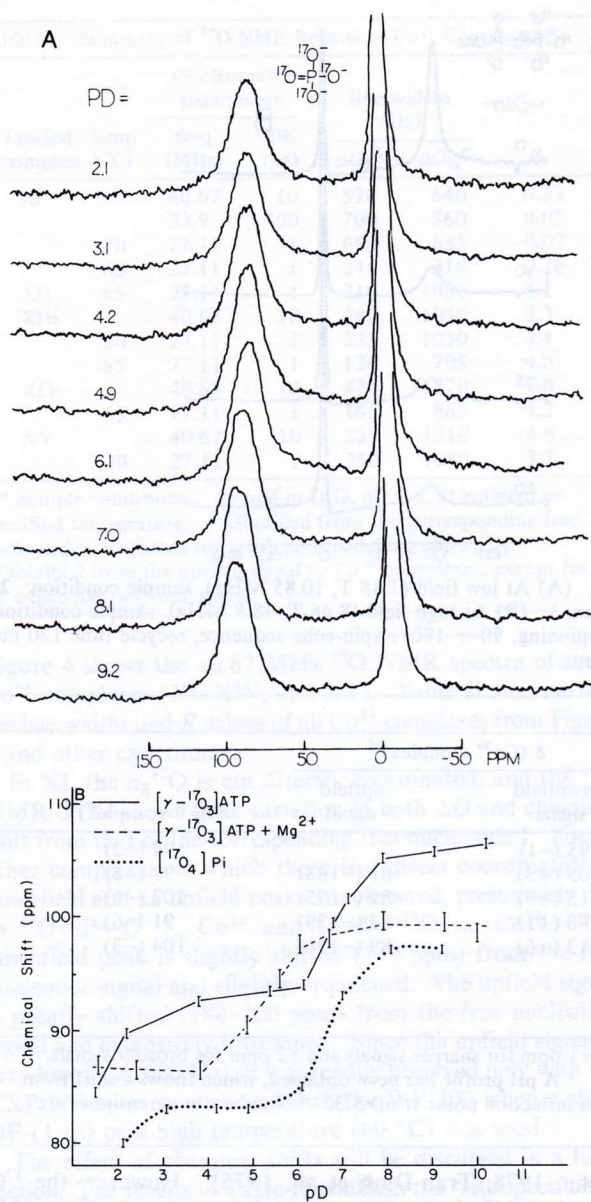

FIGURE 7: (A) Low-field (1.88 T, 10.85 MHz) ^{17}O NMR spectra of $[\text{O}_4]^{17}\text{P}_i$ at various pD. Sample condition: 25 mM in D_2O , with pD adjusted by DCl and NaOH; EDTA 2 mM. Spectrometer (Varian FT-80) condition: spectral width 8 kHz, 1.6 K data points, DE = 200 μs , deuterium lock, recycle time 120 ms, 20 000 transients. (B) Plot of chemical shifts vs. pD for $[\text{O}_4]^{17}\text{P}_i$ [from the spectra in (A)] and $[\gamma\text{-}^{17}\text{O}_3]\text{ATP}$ (III) and $\text{Mg}^{2+}/[\gamma\text{-}^{17}\text{O}_3]\text{ATP}$ at medium field (4.7 T, 27.11 MHz). Sample conditions for ATP: 25 mM in D_2O , EDTA 1 mM. Spectrometer parameters (Bruker WP-200): 2K data points, spectral width 20 kHz, DE = 12 μs , deuterium lock, recycle time 60 ms, line broadening 40 Hz, 15 000 transients. The chemical shift is taken at the center of each peak.

$^{17}\text{O}=\text{P}-\text{O}^- \dots \text{Co}^{3+}$, but the unequivocal assignment is awaiting preparation of single diastereomers of the Co^{3+} complexes of singly and stereospecifically labeled nucleotides.

Also noteworthy in Table III are the following: (1) The chemical shifts of fully deionized free nucleotides are $[\alpha\text{-}^{17}\text{O}]\text{ATP} < [\beta\text{-}^{17}\text{O}]\text{ATP} < [\gamma\text{-}^{17}\text{O}]\text{ATP}$; $[\alpha\text{-}^{17}\text{O}]\text{ADP} < [\beta\text{-}^{17}\text{O}]\text{ADP}$. (2) Sulfur substitution of both AMP (at P_α) and ATP (at P_γ) causes a 40–50-ppm downfield shift.

While the chemical shift effect is quite large in Co^{3+} complexes, the line-broadening effect has been consistent in all complexes. Although it is yet to be confirmed that there is no other undetected signal (which may be very broad and shifted upfield) for Mg^{2+} complexes, the line-broadening effect is more obvious than the chemical shift effect for the observed

signal of all Mg^{2+} complexes. Another important reason for us to emphasize the line-broadening effect is that in macromolecular systems the ^{17}O NMR signal may not be observed due to quadrupolar broadening. In that case the ^{17}O relaxation may be monitored by the $^{31}\text{P}(^{17}\text{O})$ NMR method (Tsai et al., 1980). A "line-sharpening effect" has indeed been observed for most Mg^{2+} complexes in $^{31}\text{P}(^{17}\text{O})$ NMR, which indirectly supports that the "line-broadening effect" in ^{17}O NMR is of quadrupolar nature rather than nonspecific (Tsai, 1982).

The major drawback of the line-width approach is the quantitation. The quantitative relationship between the "R" value and the extent of binding remains to be established.

Detailed Mechanism. According to eq 1, the ^{17}O relaxation time T_q is determined by three factors: the asymmetry parameter η , the quadrupolar coupling constant e^2qQ/h , and the rotational correlation time τ_r . Although it is well established that "binding" causes the oxygen T_q to decrease, it is difficult at this stage to quantitatively define the contribution from each factor. Since $0 \leq \eta \leq 1$, the effect of $(1 + \eta^2/3)$ is generally small. In the case of the binding of quadrupolar ions to macromolecules, both e^2qQ/h and τ_r can change greatly (James, 1975; Wuthrich, 1976). In the present case, e^2qQ/h is expected to be the major factor which changes upon binding, although an increase in the "local rotational correlation time" cannot be completely ruled out. The "molecular tumbling" is not expected to change greatly upon binding since the molecular size of metal-nucleotide complexes should not be quite different from that of free nucleotides. The "site specificity" established by Co^{3+} complexes has ruled out the molecular tumbling as the major factor which changes upon binding. However, it is not clear why the downfield peak in Figure 4 (due to $^{17}\text{O}=\text{P}-\text{O}^- \dots \text{Co}^{3+}$) is also slightly broadened. It may be caused by a combination of several factors.

A complete understanding of the mechanism of the line-broadening effect would require independent measurements of η , e^2qQ/h and τ_r , of singly (and stereospecifically) labeled nucleotides in case of Co^{3+} complexes. In other noninert complexes it can be more complicated.

Conclusion

We have presented a new approach by use of ^{17}O NMR to study the binding of nucleotides with diamagnetic metal ions. Study of Mg^{2+} complexes with adenine nucleotides indicates that the α -phosphate of ATP is at least partially involved in the binding with Mg^{2+} . By use of Co^{3+} complexes we have shown that both the line-broadening effect and the chemical shift effect of diamagnetic metal ions in ^{17}O NMR is specific to binding sites. The ^{17}O NMR method seems to be an adequate method to study the effect of binding, but the result is only semiquantitative at the present stage. The nonspecific factors (factors not related to the quadrupolar effect) should not dominate the results, but a small contribution by a combination of them cannot be ruled out. The possible effect of the self-association of nucleotides (Scheller et al., 1981) has not been considered.

The conclusion of this work should be considered only as the most likely explanation of the results in order not to add confusion to the already controversial problem based on previous ^{31}P NMR studies. A more quantitative and fundamental investigation is still required, and new information may still be uncovered by advancement in instrumentation.

Acknowledgments

The early stage of this work involved useful discussion with Professors W. W. Cleland (University of Wisconsin), M. Cohn

(University of Pennsylvania), A. S. Mildvan (Fox Chase Institute), B. D. N. Rao (Purdue University), and G. H. Reed (University of Pennsylvania), to whom we are indebted. We also thank Professors E. Oldfield (University of Illinois) and D. Fiat (University of Illinois), Drs. J. P. Yesinowski and F. Ezra (Procter and Gamble), and JEOL for obtaining some ^{17}O NMR spectra on their spectrometers. Professor J. A. Gerlt (Yale University) is acknowledged for providing us the information on J_{P-O} of nucleotides prior to publication.

References

- Abbott, S. J., Jones, S. R., Weinman, S. A., Bockoff, F. M., McLafferty, F. W., & Knowles, J. R. (1979) *J. Am. Chem. Soc.* 101, 4323-4332.
- Abraham, A. (1961) *The Principles of Nuclear Magnetism*, Oxford University Press, London and New York.
- Bishop, E. O., Kimber, S. J., Orchard, D., & Smith, B. E. (1981) *Biochim. Biophys. Acta* 635, 63-72.
- Brintzinger, H. (1963) *Biochim. Biophys. Acta* 77, 345-348.
- Brown, F. F., Campbell, I. D., Henson, R., Hirst, C. W. J., & Richards, R. E. (1973) *Eur. J. Biochem.* 38, 54-58.
- Bryant, R. G. (1972) *J. Magn. Reson.* 6, 159-166.
- Bryant, R. G. (1978) *Annu. Rev. Phys. Chem.* 29, 167-188.
- Canet, D., Goulon-Giret, C., & Marchal, J. P. (1976) *J. Magn. Reson.* 22, 537-542.
- Cleland, W. W. (1982) *Methods Enzymol.* (in press).
- Cleland, W. W., & Mildvan, A. S. (1979) *Adv. Inorg. Biochem.* 1, 163-191.
- Cohn, M., & Hughes, T. R., Jr. (1962) *J. Biol. Chem.* 237, 176-181.
- Cohn, M., & Hu, A. (1978) *Proc. Natl. Acad. Sci. U.S.A.* 75, 200-203.
- Cohn, M., & Hu, A. (1980) *J. Am. Chem. Soc.* 102, 913-916.
- Collins, T. R., Starcuk, Z., Burr, A. H., & Wells, E. J. (1973) *J. Am. Chem. Soc.* 95, 1649-1656.
- Cornelius, R. D., Hart, P. A., & Cleland, W. W. (1977) *Inorg. Chem.* 16, 2799-2805.
- Diebler, V. H., Eigen, M., & Hammes, G. G. (1960) *Z. Naturforsch., B: Anorg. Chem., Org. Chem., Biochem., Biophys., Biol.* 15B, 554-560.
- Dunaway-Mariano, D., & Cleland, W. W. (1980a) *Biochemistry* 19, 1496-1505.
- Dunaway-Mariano, D., & Cleland, W. W. (1980b) *Biochemistry* 19, 1506-1515.
- Eckstein, F., & Goody, R. S. (1976), *Biochemistry* 15, 1685-1691.
- Eichhorn, G. L. (1972) in *Inorganic Biochemistry* (Eichhorn, G. L., Ed.) Vol. 2, pp 1207-1209, Elsevier, New York.
- Gupta, R. K., & Mildvan, A. S. (1977) *J. Biol. Chem.* 252, 5967-5976.
- Jaffe, E. K., & Cohn, M. (1978) *Biochemistry* 17, 652-657.
- Jaffe, E. K., & Cohn, M. (1979) *J. Biol. Chem.* 254, 10839-10845.
- James, T. L. (1975) *Nuclear Magnetic Resonance in Biochemistry*, pp 48-49, Academic Press, New York.
- Kuntz, G. P. P., & Swift, T. J. (1973) *Fed. Proc., Fed. Am. Soc. Exp. Biol.* 32, 546.
- Lam, Y.-F., Kuntz, G. P. P., & Kotowycz, G. (1974) *J. Am. Chem. Soc.* 96, 1834-1839.
- Magnusson, J. A., & Bothner-by, A. A. (1971) in *Magnetic Resonance in Biological Research* (Franconi, C., Ed.) pp 365-376, Gordon and Breach, New York.
- Marshall, A. G. (1970) *J. Chem. Phys.* 52, 2527-2534.
- Merritt, E. A., Sundaralingam, M., Cornelius, R. D., & Cleland, W. W. (1978) *Biochemistry* 17, 3274-3278.
- Mildvan, A. S. (1977) *Acc. Chem. Res.* 10, 246-252.
- Mildvan, A. S. (1979) *Adv. Enzymol. Relat. Areas Mol. Biol.* 49, 103-126.
- Mildvan, A. S., & Cohn, M. (1970), *Adv. Enzymol. Relat. Areas Mol. Biol.* 33, 1-70.
- Myers, T. C. (1967) in ^{31}P Nuclear Magnetic Resonance (Crutschfield, M. M., Dunga, C. H., Letcher, J. H., Mark, V., & Van Wazer, J. R., Ed.) p 314, Interscience, New York.
- Ramirez, F., & Marecek, J. F. (1980) *Biochim. Biophys. Acta* 589, 21-29.
- Rodger, C., Sheppard, N., McFarlane, H. C. E., & McFarlane, W. (1978) in *NMR and the Periodic Table* (Harris, R. K., & Mann, B. E., Eds.) Chapter 12A, Academic Press, London.
- Sadlej, J., & Sadlej, A. J. (1974), *J. Magn. Reson.* 14, 97.
- Scheller, K. H., Hofstetter, F., Mitchell, P. R., Prijs, B., & Sigel, H. (1981) *J. Am. Chem. Soc.* 103, 247-260.
- Swift, T. J., & Connick, R. E. (1962) *J. Chem. Phys.* 37, 307-320.
- Tran-Dinh, S., & Roux, M. (1977) *Eur. J. Biochem.* 76, 245-249.
- Tran-Dinh, S., Roux, M., & Ellenberger, M. (1975) *Nucleic Acids Res.* 2, 1101-1110.
- Tsai, M.-D. (1979) *Biochemistry* 18, 1468-1472.
- Tsai, M.-D. (1980) *Biochemistry* 19, 5310-5316.
- Tsai, M.-D. (1982) *Methods Enzymol.* (in press).
- Tsai, M.-D., Huang, S. L., Kozlowski, J. F., & Chang, C. C. (1980) *Biochemistry* 19, 3531-3536.
- Valentine, B., St. Amour, T., Walter, R., & Fiat, D. (1980) *J. Magn. Reson.* 38, 413-418.
- Villafranca, J. J., & Raushel, F. M. (1980) *Annu. Rev. Biophys. Bioeng.* 9, 363-392.
- Wuthrich, K. (1976) *NMR in Biological Research*, pp 329-334, North-Holland Publishing Co., Amsterdam and Oxford.